

VIEW "A"
(SCALE : 4/1)

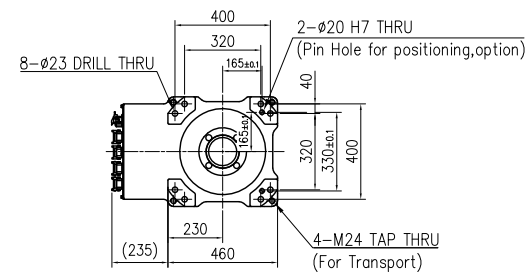

VIEW "B"
(SCALE : 1/1)

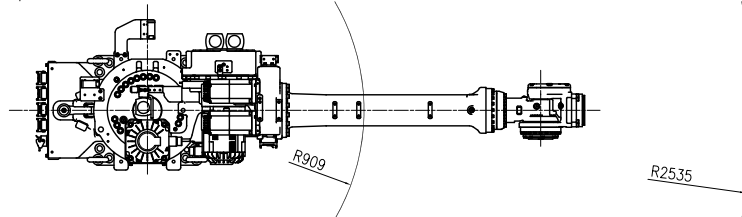
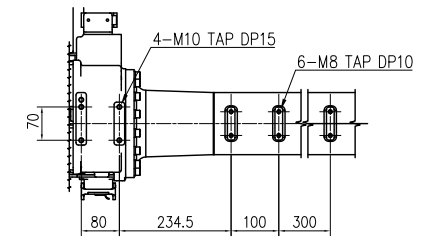

VIEW "E"
(SCALE : 2/1)

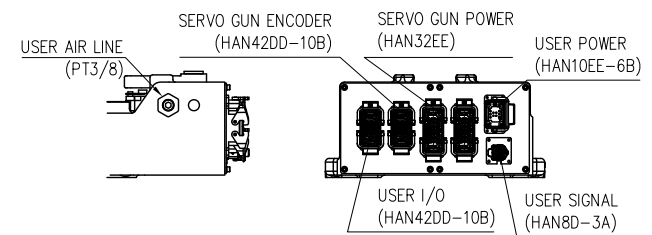
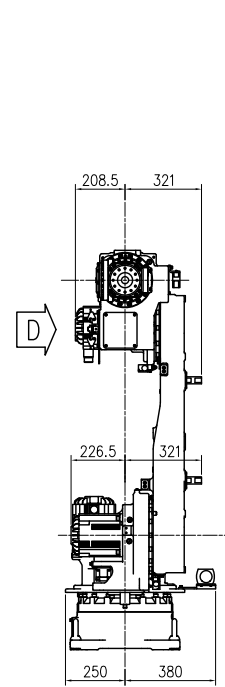
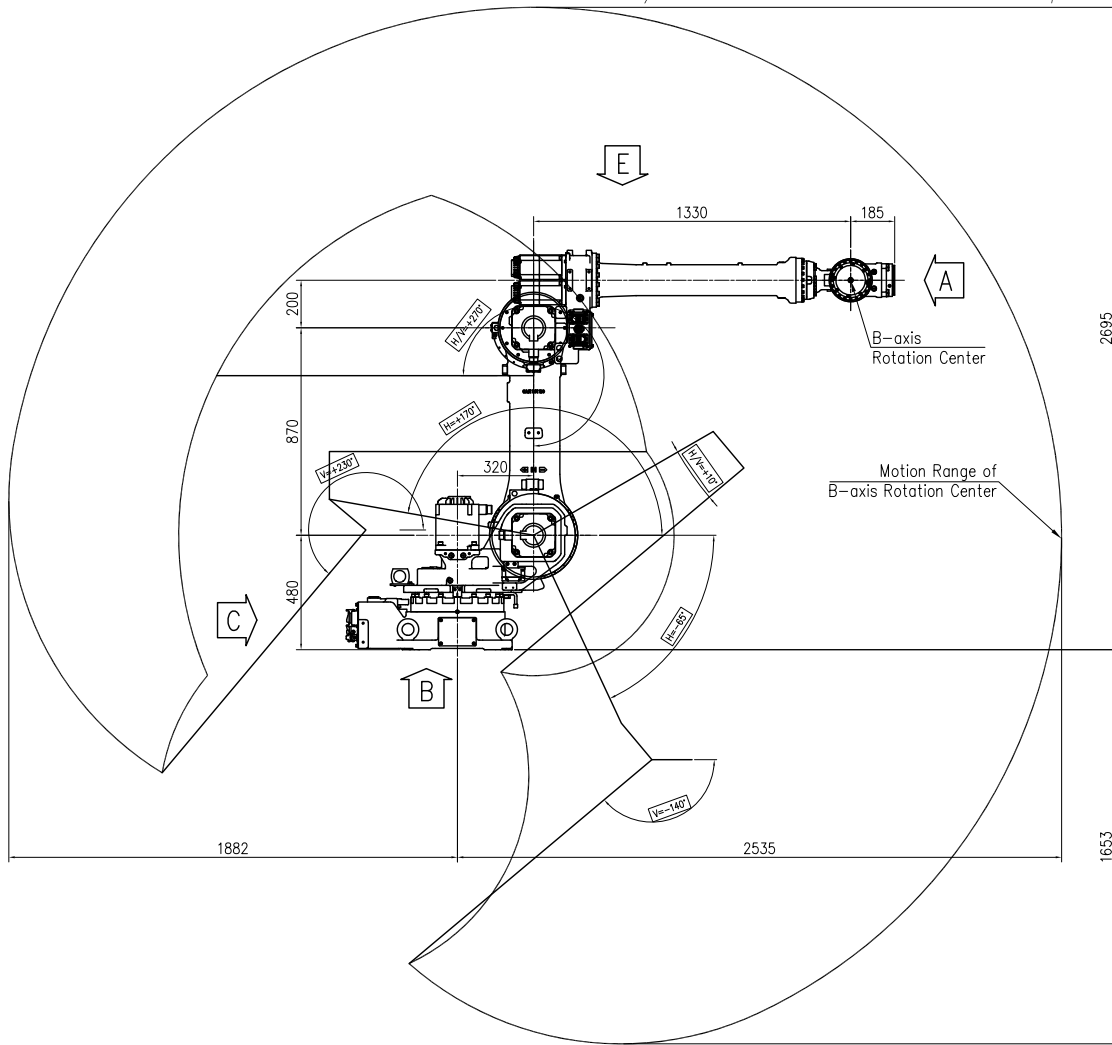

VIEW "C" <For Hi5a Controller>
(SCALE : 2/1)

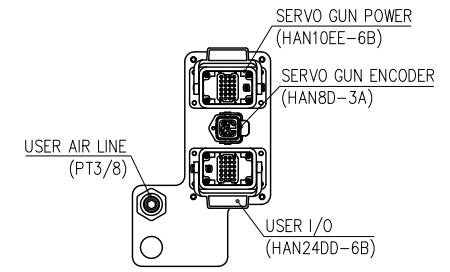

VIEW "D"
(SCALE : 4/1)

MODEL	HH030L-11	issue.2
DATE	2015.03.05	

TECHNICAL SPECIFICATION SUBJECT TO CHANGE WITHOUT NOTICE