

VIEW "A"
(SCALE : 2/1)

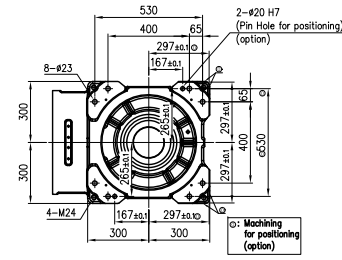

VIEW "B"
(SCALE : 1/1)

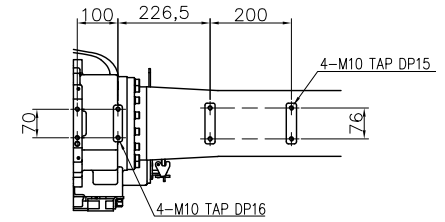

VIEW "E"
(SCALE : 2/1)

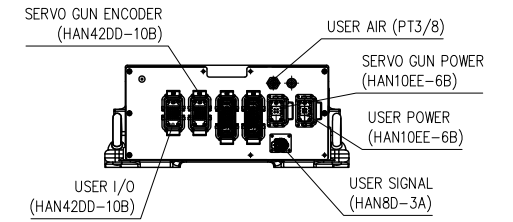
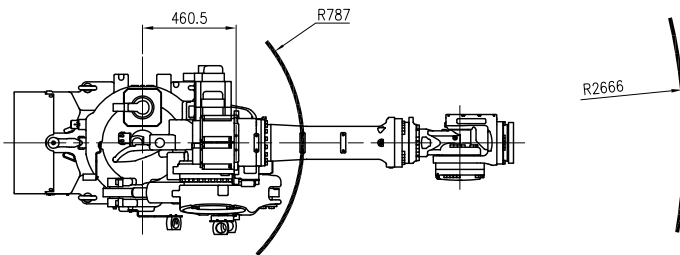

VIEW "C"
(SCALE : 2/1)

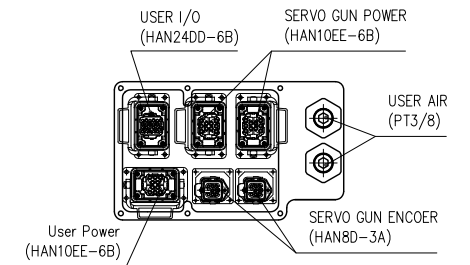
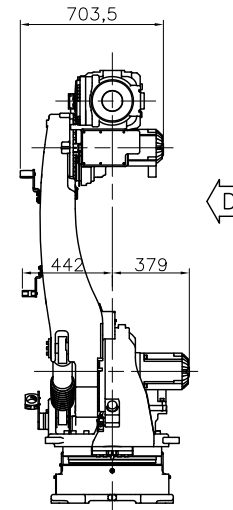
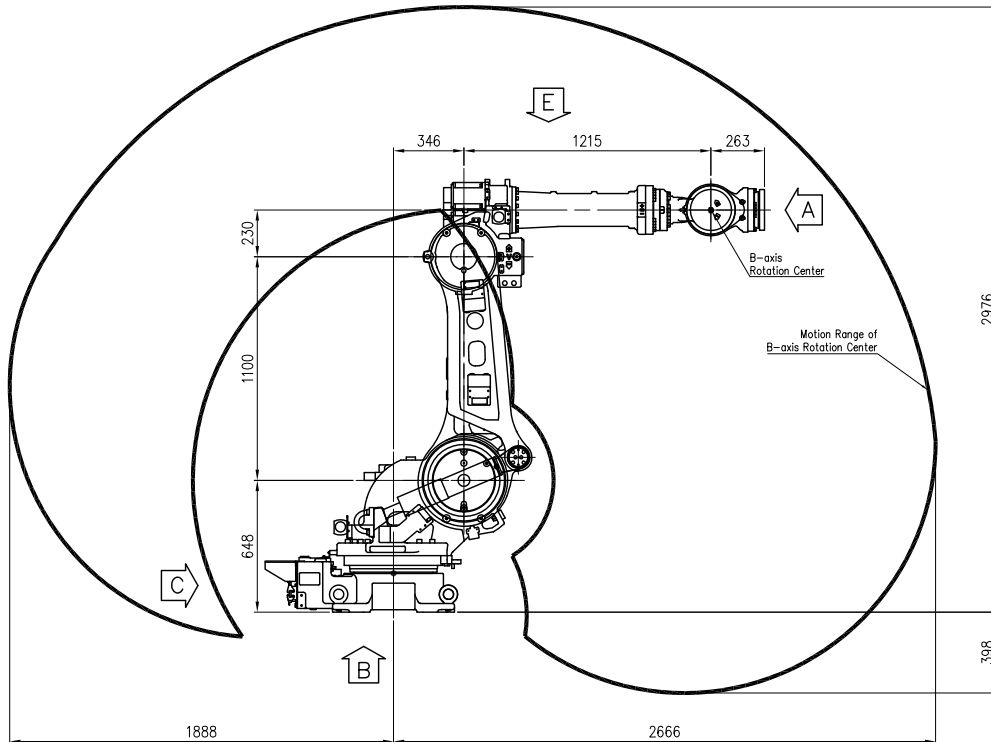

VIEW "D"
(SCALE : 2/1)

BASIC SPECIFICATION OF HH300. PLEASE, REFER TO THE CATALOGUE.

Maximum Operating Range	Arm	S (Swivel)	±180° (±178°: LS Option)
		H (Horizontal)	+155° ~ +10°
		V (Vertical)	+190° ~ -80° (+190° ~ -73°: LS Option)
		H/V (Interference)	+10° ~ +280° (+17° ~ +280°: LS Option)

MODEL	HH300	issue.2
DATE	2015.03.13	

HYUNDAI HEAVY INDUSTRIES CO.,LTD.
ENGINE & MACHINERY DIVISION

TECHNICAL SPECIFICATION SUBJECT TO
CHANGE WITHOUT NOTICE